

# KBR - 1500

## Cleaning Procedure

Dirty sensors can cause false errors such as Double and Half errors, and may decrease the performance of the Kolibri KBR-1500 Currency Discriminator. It is suggested that the user performs daily maintenance on the unit to maintain top performance.

The unit should always be turned off and disconnected from its power cord before cleaning. DO NOT use solvents such as thinner, alcohol, etc. to clean the machine.

Most operational problems can be avoided by regular care and preventative maintenance. Taking regular care of the KBR-1500 will significantly increase its lifetime.

For best results, it is recommended to use an air duster and a soft bristle brush to remove any dust or debris from the interior of the unit. When not using the machine for an extended period, cover it with the dust cover (not included with the unit) to prevent dust from settling inside.

All parts of the Kolibri KBR-1500 need daily care and cleaning. Pay close attention to the sensors, which are delicate components. If any dust or other foreign matter adheres to the sensors, it may cause various problems during operation of the machine.

- To avoid malfunction caused by foreign objects, please clean your machine every day.
- Clean back door sensors with the provided bristle brush or a dry cloth frequently.
- Clean inner sensors with the provided dry cloth frequently.
- Clean hopper and stacker sensors with the provided bristle brush or a dry cloth frequently.
- Rubber rollers may be cleaned with a slightly damp cloth. You may use a small amount of liquid soap on the cloth, but the soap residue should properly removed.

# KBR - 1500

## Cleaning Procedure

### Kolibri KBR-1500 Sensors (continued)

3. Position Sensors (IR) - Eight Sensors (four pairs)
4. Contact Image Sensors (CIS) - Two Sensor Bars
5. Ultraviolet Sensor (UV) - Two Sensors
6. Magnetic Sensors (MG) - Two Sensors

Figure 3: To reach the inner and back door sensors, locate the latch on the back of the KBR-1500. Pinch and pull out and down to open the back of the unit (see additional images below).

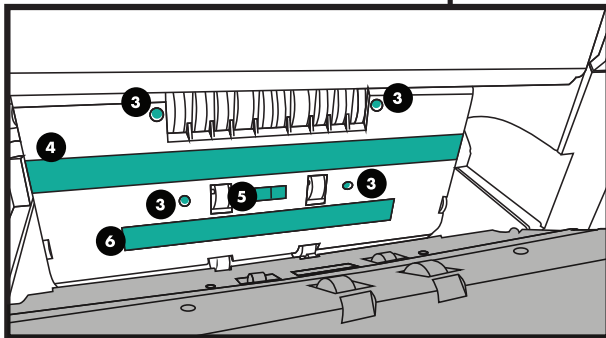
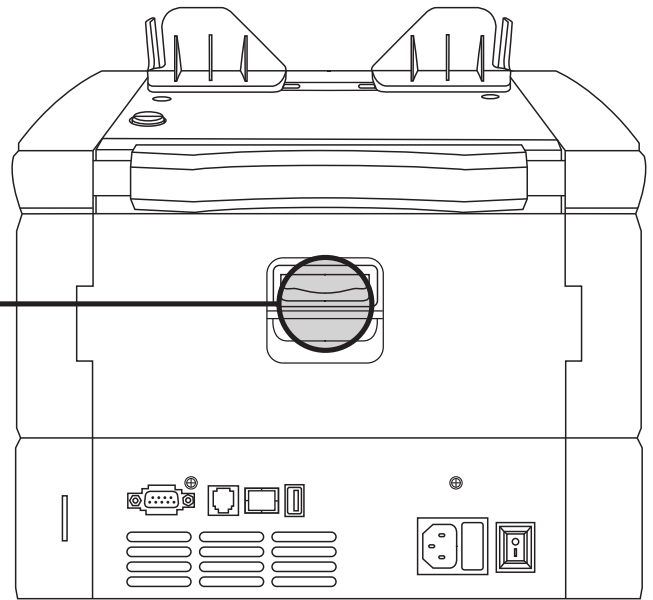
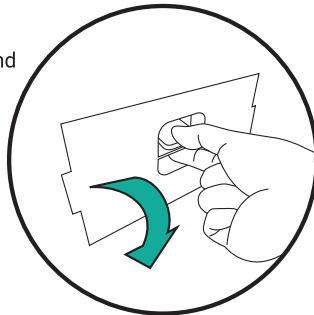

Figure 4: Inner sensors - Four pairs of positioning sensors, two large CIS sensor bars, two UV sensors, two large MG sensor bars.

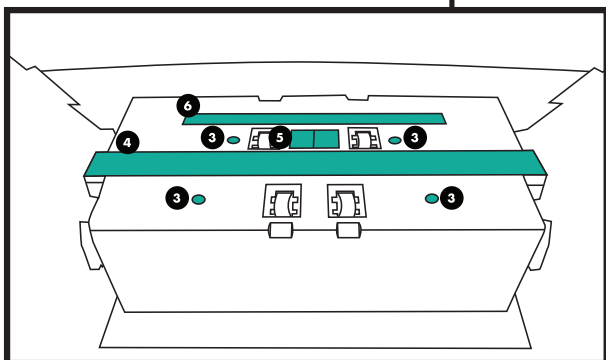

Figure 5: Back door sensors correspond to inner sensors (shown above).

Kolibri suggests that the user cleans the unit at least once per week. For heavy use locations and operations, the user may clean the unit daily to avoid heavy buildup that may cause improper operation. When the unit is not in use, Kolibri suggests that the user covers the unit with a dust cover.

If, after cleaning all sensors, this does not resolve the issue, please see the support section on the Kolibri USA website at [www.kolibriusa.com](http://www.kolibriusa.com), or contact Kolibri Support at [support@kolibriusa.com](mailto:support@kolibriusa.com) for further troubleshooting.

# KBR - 1500

## Cleaning Procedure

### Kolibri KBR-1500 Sensors

1. Hopper Sensor - One Sensor
2. Stacker Sensors - Two Sensors

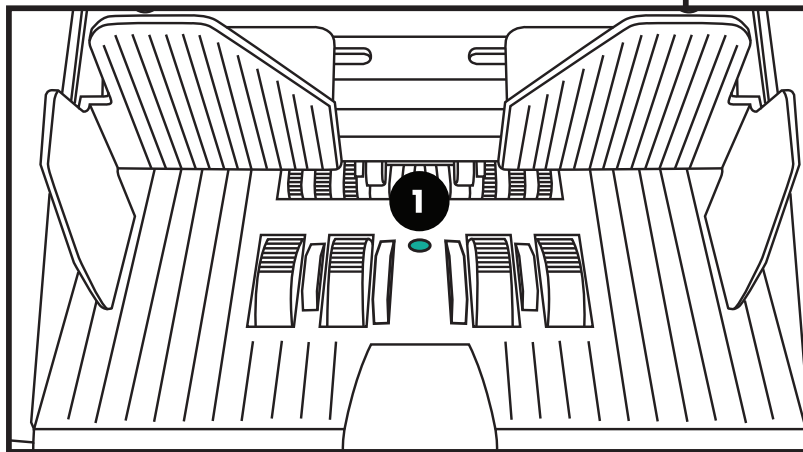

Figure 1: Hopper Sensor (black circular sensor in center), located at top of unit where bills are placed.

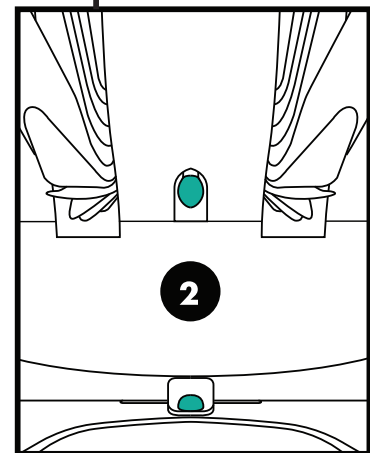
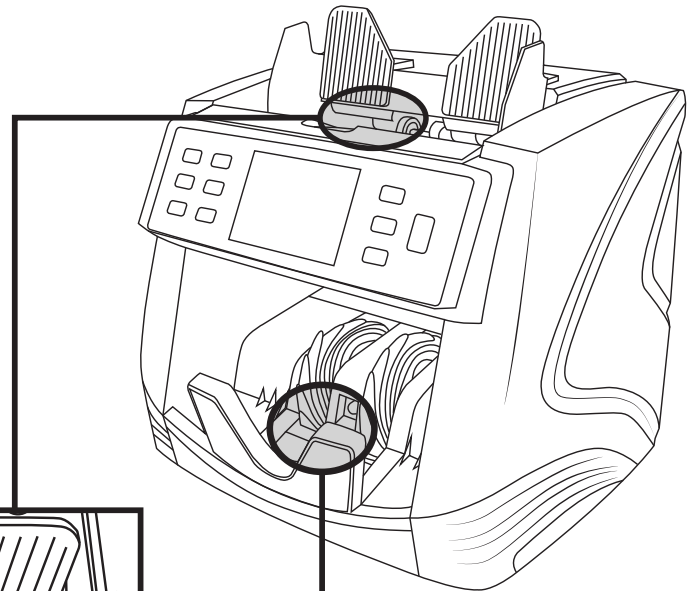

Figure 2: Stacker Sensors (clear LED and black LED), located where money is stacked after counting.